

Front

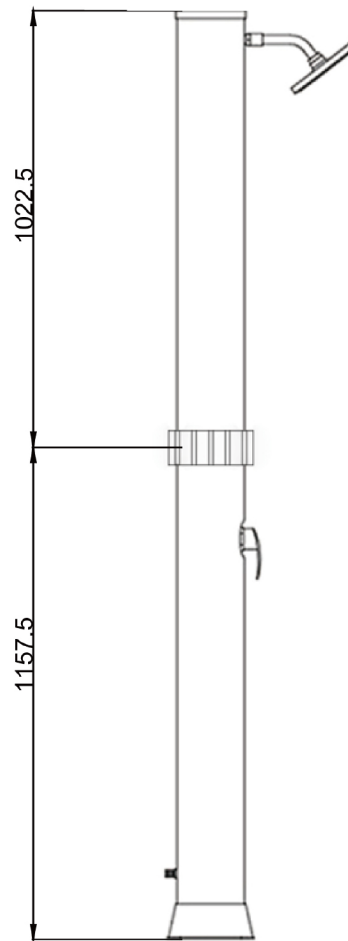

Lateral

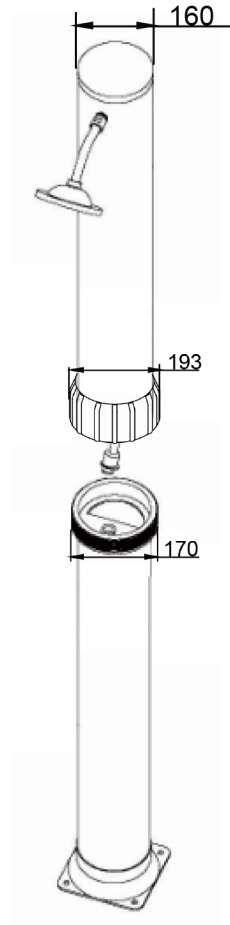

Diameter

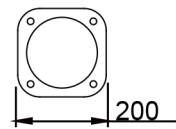

Bottom

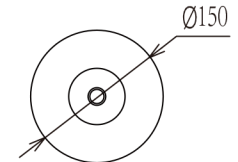
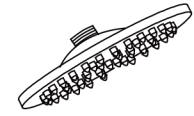

Top

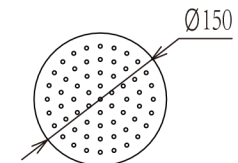

Bottom

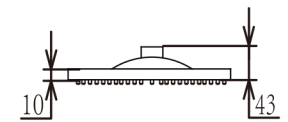

Front